





NEW

F33T

Universal tyre-changer for truck, bus, agriculture and earth moving vehicles 14" - 46" (with optional extensions: 56")

-  Mandrino idraulico a due velocità con 5 differenti posizioni di bloccaggio del cerchio, unità di comando mobile equipaggiata con cavo anti schiacciamento e doppia spina militare.
-  Two speed hydraulic chuck with 5 different rim locking positions, mobile control unit with anti-crush cable and double military plug.
-  Mandrin hydraulique à deux vitesses avec 5 différentes positions de blocage, unité de commande mobile avec câble anti-écrasement et double prise militaire.
-  Idraulisches Spannfutter mit zwei Drehgeschwindigkeiten und fünf verschiedenen Felgenspannstellungen, mobiler Steuereinheit komplett mit schlagfestem Kabel und Doppelmilitärstecker.
-  Mandril hidráulico de dos velocidades con 5 diferentes posiciones de bloqueo de la llanta, unidad de control móvil equipada con cable anti aplastamiento y doble enchufe militar.



Dati tecnici - Standard Features - Données Techniques - Technische Angaben - Datos Tecnicos

Per ruote da:	It handles wheels from:	Pour roues de:	Für Räder von:	14" - 46"
Con prolunghe opzionali:	With optional extensions:	Avec rallonges en option:	Verlängerungen als Option:	14" - 56"
Peso max. ruota	Max. wheel weight	Poids maxi. roue	Maximalgewicht des Rads	1500 Kg
Larghezza max. ruota	Max. wheel width	Largeur maxi. roue	Radbreite	1.065 mm (42")
Diametro max. ruota	Max. wheel diameter	Diam. maxi. roue	Max. Raddurchmesser	2.300 mm (90,5")
Motore centralina idraulica	Hydraulic unit motor	Moteur de la centrale hydraulique	Hydraulikaggregat-Motor	1.1 kW / 380V
Motore mandrino autocentrante	Chuck motor	Moteur du mandrin centreur	Spannfuttermotor	1,3 - 1,8 kW / 3 ph - 380 V
Pressione di servizio	Operating pressure	Pression de Service	Betriebsdruck	0 ÷ 130 bar
Forza stallonatore	Bead breaker force	Force décolleur	Abdrückkraft	2690 Kg
Peso lordo	Gross weight	Poids brut	Bruttogewicht	816 Kg
Dimensioni imballo	Packing dimensions	Dimensions emballage	Kistenabmessungen	2020x1700x1020 h mm

Accessori standard - Standard accessories - Accessoires en dotation - Standard Zubehörteile - Accesorios en dotación



Leva per cerchietti
Rim lever
Levier pour tringles
Hebel für Wulstkerne
Palanca para aritos



Leva alzatalloni
Bead lifting lever
Levier décolle-talons
Wulstausdrückhebel
Palanca destalonadora



Pinza per cerchi
Rim pliers
Pince pour jantes
Felgenzange
Tenaza para llantas

Accessori opzionali - Optional accessories - Accessoires sur demande - Optionszubehörteile - Accesorios opcionales



Pinza per cerchi in lega
Pliers for alloy rims
Pince pour jantes en alliage
Zange für Leichtlegierunselgen
Tenaza para llantas en liga

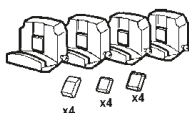

Serie di protezioni griffe per cerchi in lega
Jaw protections for alloy rims
Protections des griffes pour jantes en alliage
Satz von Klauenschütze für Leichtlegierunselgen
Juego de protecciones mordazas para llantas en liga



Set di 4 prolunghe fino a 56"
Set of 4 extensions up to 56"
Set de 4 rallonges jusqu'à 56"
Set mit 4 Verlängerungen bis 56"
Juego de 4 extensiones hasta 56"

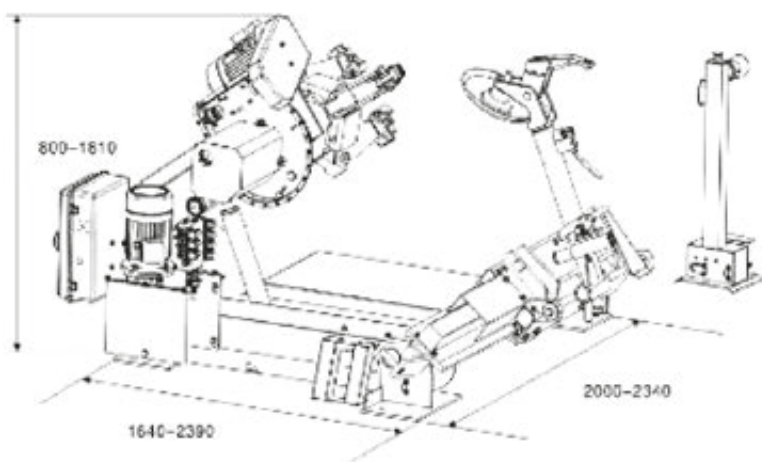

HEAVY DUTY BRONZE BEARINGS



23826 Mandello del Lario (Lc) - Italy
Tel. +39.0341.706111 - Fax +39.0341.700725
www.focus-1.it